

TECHNICAL CHARACTERISTICS

- Aluminium alloy construction
- Smooth operation
- High efficiency impeller
- Maintenance free
- Mountable in any position
- Recognized TEFC - cURus motor

OPTIONS

- Special voltages (IEC 38)
- Surface treatments

ACCESSORIES

- Inlet and/or inline filters
- Additional inlet/outlet silencers
- Safety valves
- Flow converting device
- Optional connectors

Dimensions in inches.
Dimension for reference only.

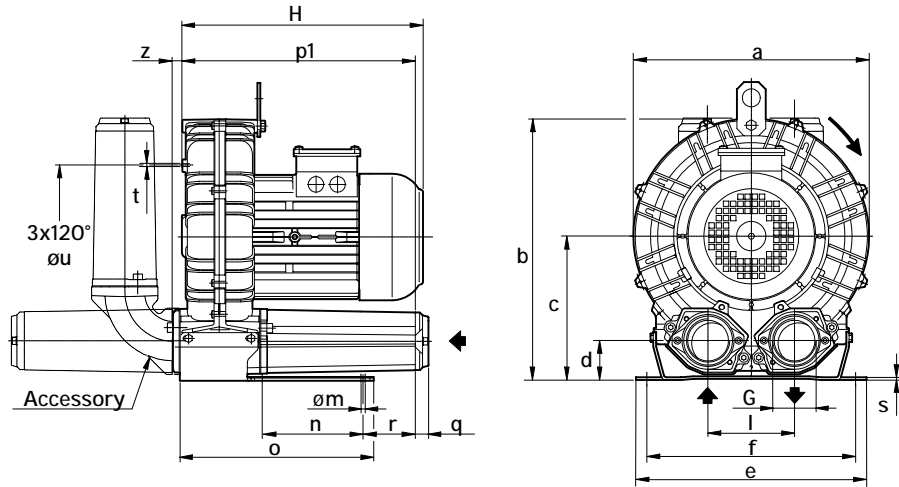

| Model | a | b | c | d | e | f | G | l | m | n | o | p1 | q | r | s | t | u | z |
|--------|-------|-------|------|------|-------|-------|-----------|------|------|------|-------|-------|------|------|------|----|------|------|
| K03-MS | 9.49 | 10.55 | 5.79 | 1.69 | 9.06 | 8.07 | 1"1/4 NPT | 3.39 | 0.39 | 3.27 | 5.59 | 8.07 | 0.71 | 2.95 | 0.16 | M6 | 5.51 | 0.47 |
| K04-MS | 11.22 | 12.40 | 6.77 | 1.93 | 10.04 | 8.86 | 1"1/2 NPT | 4.02 | 0.47 | 3.74 | 6.73 | 8.74 | 0.71 | 2.76 | 0.16 | M6 | 6.89 | 0.71 |
| K05-MS | 12.87 | 14.37 | 7.87 | 2.13 | 12.80 | 10.24 | 2" NPT | 4.72 | 0.59 | 4.53 | 10.43 | 12.60 | 0.71 | 3.86 | 0.16 | M8 | 7.87 | 0.75 |
| K06-MS | 14.80 | 15.47 | 8.07 | 2.13 | 12.80 | 11.42 | 2" NPT | 4.92 | 0.59 | 5.51 | 10.71 | 13.15 | 0.71 | 3.35 | 0.16 | M8 | 9.45 | 0.75 |

| Model | Maximum flow Scfm | | Installed power Hp | | Maximum differential pressure Δp (In WG) | | Noise level Lp dB (A) ⁽¹⁾ | | Overall dimensions H Inches | Weight Lbs |
|--------|-------------------|-------------------|--------------------|-------------------|--|-------------------|--------------------------------------|-------------------|-----------------------------|------------|
| | 60 Hz 3500 rpm | 50 Hz 2900 rpm | 60 Hz 3500 rpm | 50 Hz 2900 rpm | 60 Hz 3500 rpm | 50 Hz 2900 rpm | 60 Hz 3500 rpm | 50 Hz 2900 rpm | | |
| K03-MS | 52 | 43 | 3/4 | 3/4 | 64 | 60 | 62.0 | 60.0 | 10.43 | 24.3 |
| | | | 1 | 1 | 95 | 72 | 62.3 | 60.3 | 12.0 | 32.0 |
| K04-MS | 98 | 81 | 1 1/2 | 1 1/2 | 58 | 80 | 64.8 | 62.8 | 11.65 | 40.3 |
| | | | 2 | 2 | 85 | 100 | 65.0 | 63.0 | 14.20 | 56.8 |
| | | | 3 | - | 120 | - | 65.2 | - | 14.20 | 58.4 |
| K05-MS | 156 | 129 | 2 | 2 | 52 | 70 | 70.5 | 68.5 | 13.20 | 56.7 |
| | | | 3 | 3 | 80 | 110 | 70.8 | 68.8 | 13.20 | 60.6 |
| | | | 4 | 4 | 120 | 120 | 71.1 | 69.1 | 14.40 | 77.2 |
| K06-MS | 216 | 179 | 3 | 3 | 40 | 65 | 73.0 | 71.0 | 13.80 | 69.0 |
| | | | 4 | 4 | 64 | 95 | 73.3 | 71.3 | 14.17 | 82.5 |
| | | | 5 1/2 | 5 1/2 | 110 | 130 | 73.6 | 71.6 | 15.5 | 85.3 |
| | | | 6 1/5 | - | 122 | - | 73.9 | - | 16.3 | 95.5 |

(1) Noise measured at 1 m distance with inlet and outlet ports piped, in accordance to ISO 3744.

- For proper use, the blower should be equipped with inlet filter and safety valve; other accessories available on request.
- Ambient temperature from +5° to +104°F.
- Specifications subject to change without notice.

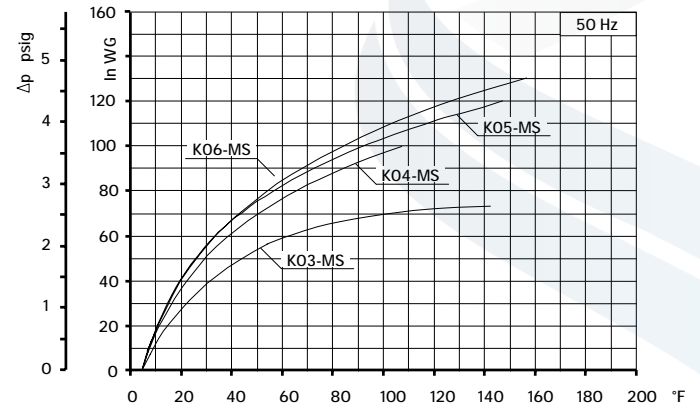
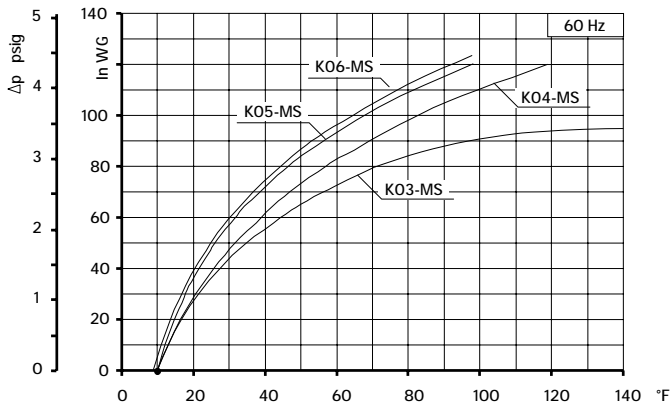
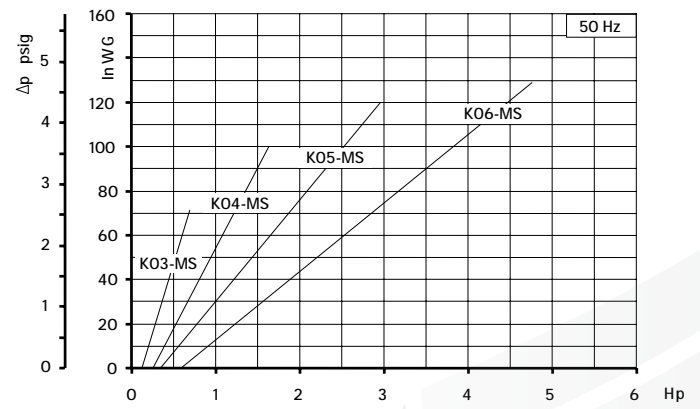
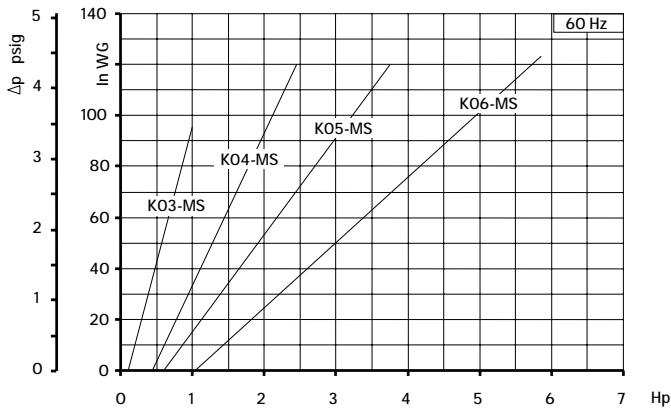
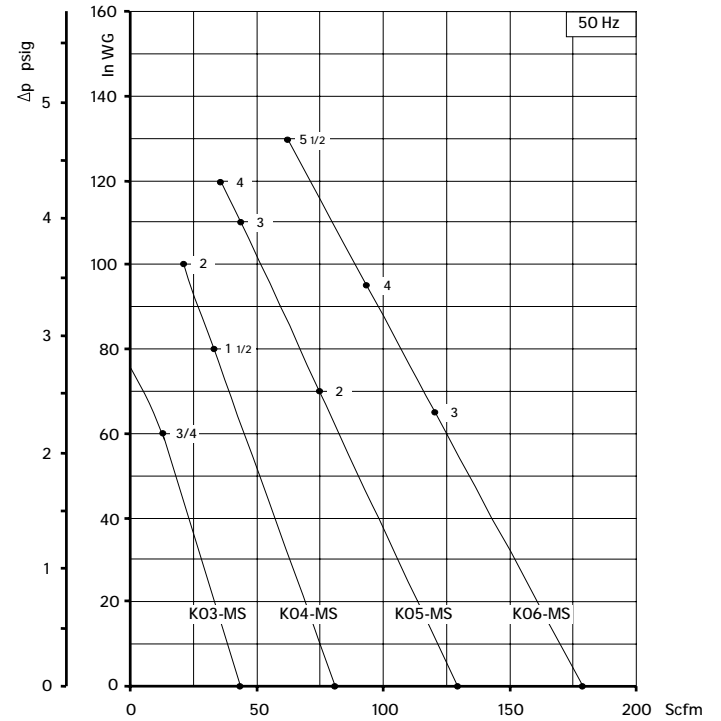
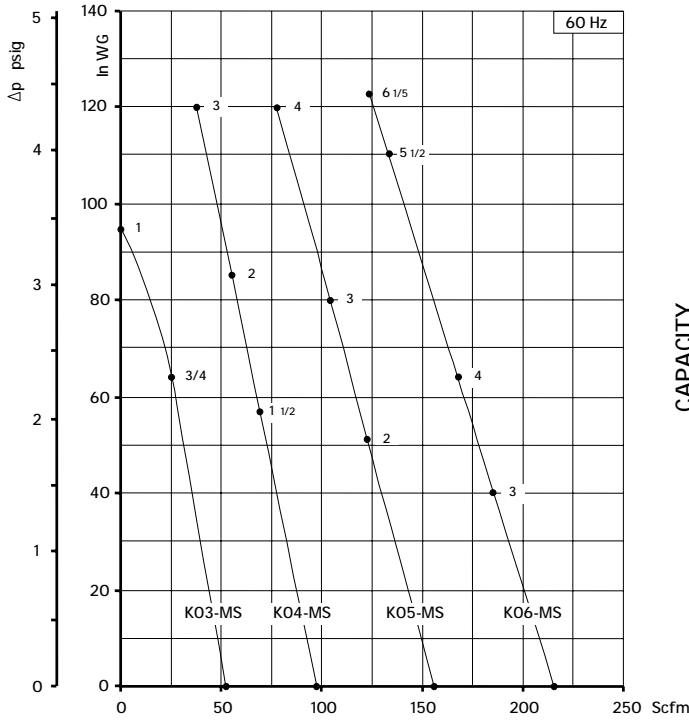

Curves refer to air at 68°F temperature and 29.92 In Hg atmospheric pressure (abs) measured at inlet port.
Values for flow, power consumption and temperature rise: +/- 10% tolerance.
Data subject to change without notice.