



Evolution Series Technical Characteristics

- Premium efficient motor
- High efficiency impeller
- Mountable in any position
- Maintenance free operation
- TEFC (IP55)

Optional Features

- Anodized aluminum components for corrosion resistance
- Increased sealing

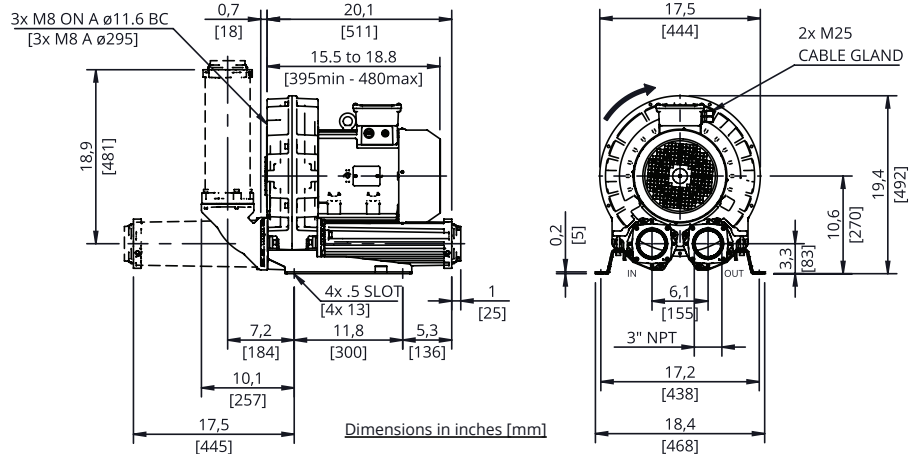

Technical Specifications

Model No.	HP	Hz	Open Flow (cfm)	Max Pressure in. H ₂ O	Max Vacuum in. H ₂ O	Efficiency	Voltage	FLA	Starting Current Ratio ¹	dB(A) ²	Weight (lb)
SCL e07-MS-4-3	4	60	307	40	40	88.5%	208-230/460	10.9-11.1/5.53	11	75	130.1
		50	254	60	60	87.1%	200/400	12.86/6.38		71	
SCL e07-MS-4-3-575	4	60	307	40	40	88.5%	575	3.94	10.1	75	130.1
SCL e07-MS-5.5-3	5.5	60	307	70	70	88.5%	208-230/460	14.6-15.1/7.55	11.1	75	132.3
		50	254	100	100	88.1%	200/400	17.7/8.86		71	
SCL e07-MS-5.5-3-575	5.5	60	307	70	70	88.5%	575	5.31	10.9	75	132.3
SCL e07-MS-7.5-3	7.5	60	307	110	110	89.5%	208-230/460	19.8-19.5/9.75	13.7	75	174.2
		50	254	140	110	89.2%	200/400	22.2/11.1		71	
SCL e07-MS-7.5-3-575	7.5	60	307	110	110	89.5%	575	7.21	13.5	75	174.2
SCL e07-MS-10-3	10	60	307	160	140	90.2%	208-230/460	26.1-25/12.5	13	75	185.2
		50	254	-	-	90.1%	200/400	28.6/14.3		71	
SCL e07-MS-10-3-575	10	60	307	160	140	90.2%	575	10	12.9	75	185.2

Motors include normally closed thermal protector, 1.15 S.F. (60 Hz), tropicalized windings, Class F (B) insulation, and are suitable for use with a VFD (Contact FPZ for pneumatic and speed limits when used with a VFD).

¹Starting current ratio x fla = starting current

²Noise level measured at a distance of 1 m with inlet and outlet ports piped in accordance to ISO 3744

Data is subject to change without notice.

Recommended Accessories

Description	Pressure Safety Valve	Vacuum Safety Valve	Pressure Filter	Vacuum Filter	Check Valve
Part Number	VRL6 (7.5 hp & 10 hp) ³	VRL6 (5.5hp - 10 hp)	FS-231P-300	CT-235P-300C	CV30
	VRL8 (4 hp & 5.5 hp) ³	VRL8 (4 hp)			

³Valve selections are based on 60 Hz and standard air. Valves are supplied uncalibrated. Safety valves are easy to calibrate, but can be ordered with factory calibration.

PRESSURE

VACUUM

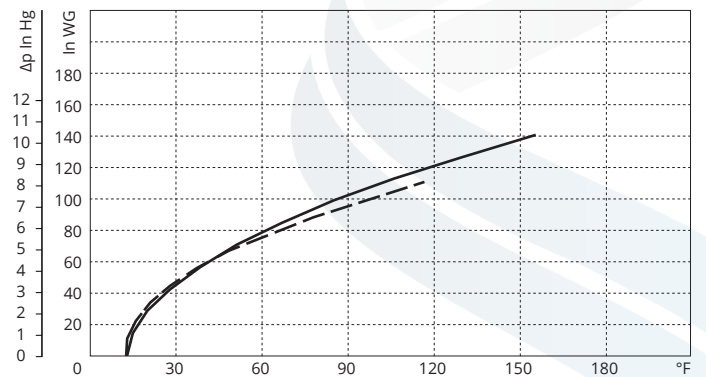
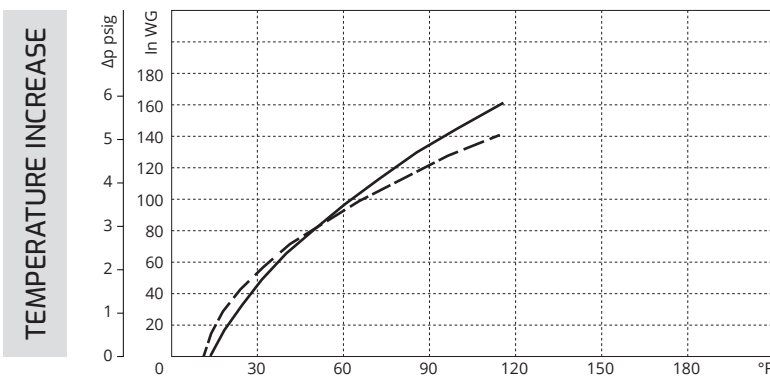
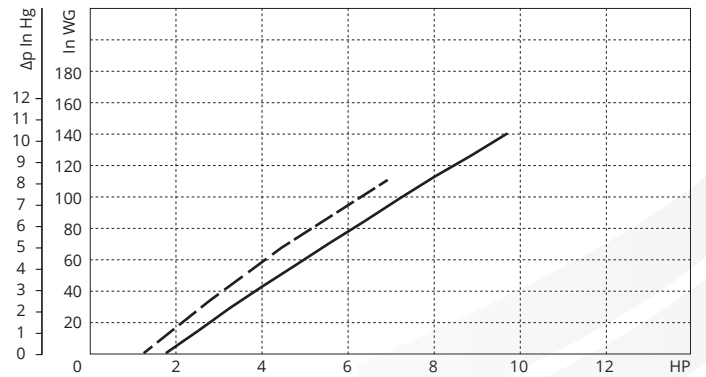
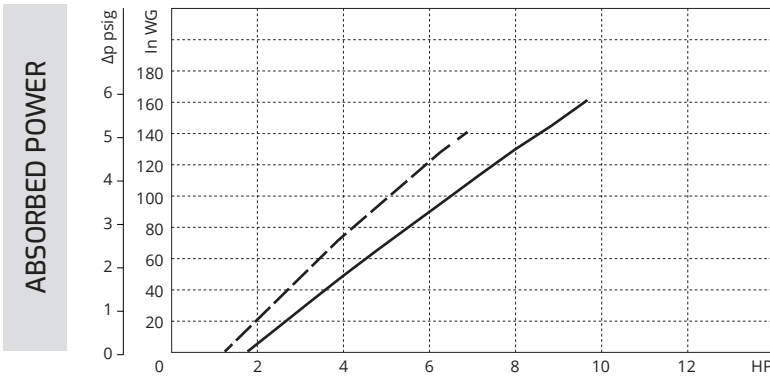
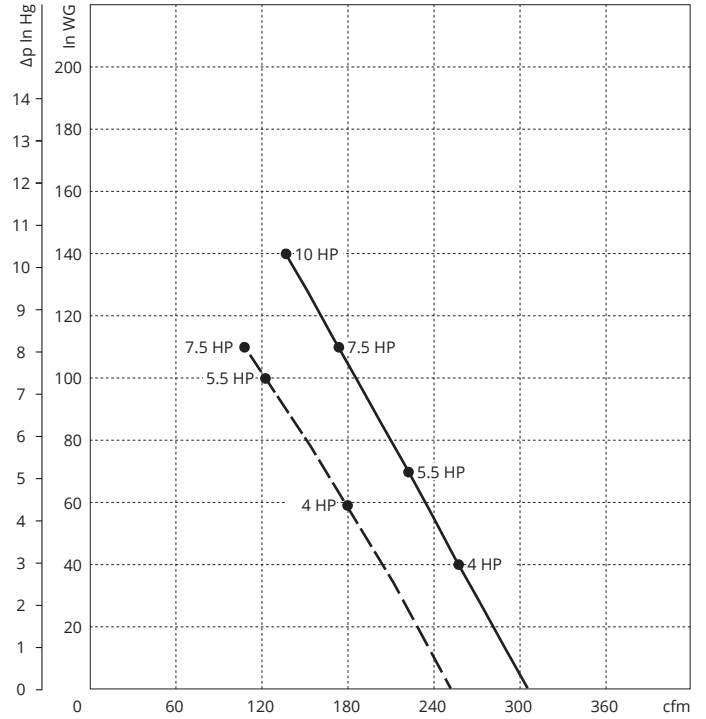
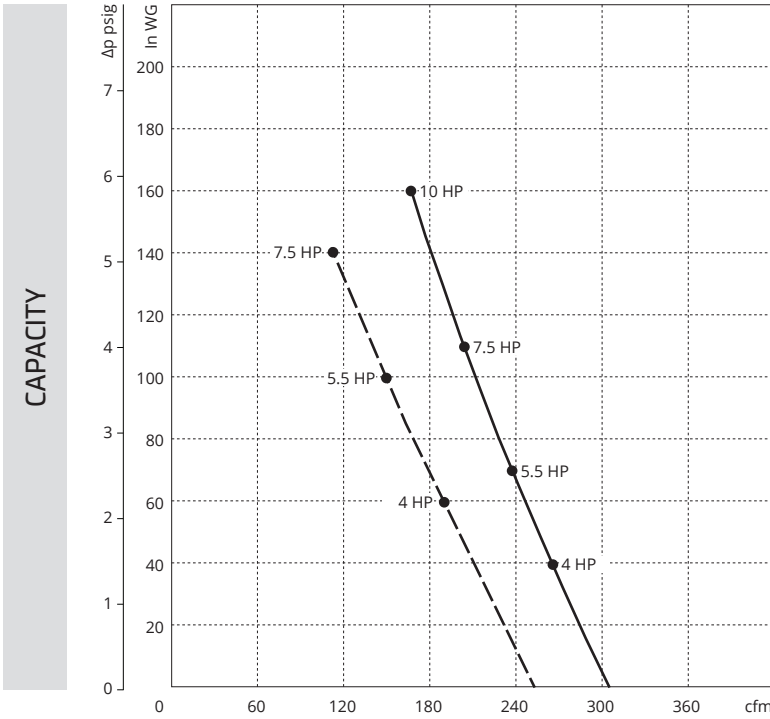

Curves refer to air at 68°F temperature and 29.92 In Hg atmospheric pressure (abs) measured at inlet port.
Values for flow, power consumption and temperature rise: +/-10% tolerance.
Data subject to change without notice.

KEY --- 50 Hz
 — 60 Hz